

# FHR

## Currents...

Fish Habitat Relationships Technical Bulletin  
Number 15 April 1994

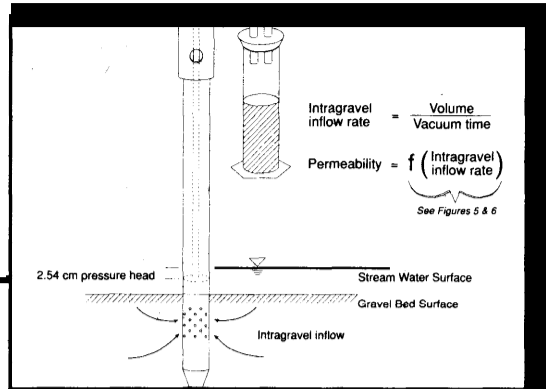

## Standpipe to Determine Permeability, Dissolved Oxygen, and Vertical Particle Size Distribution in Salmonid Spawning Gravels

Keith Barnard  
Humboldt State University  
Fisheries Department  
Arcata, CA

Scott McBain  
University of California  
Department of Civil Engineering  
Berkeley, CA

### Abstract

Gravel permeability, dissolved oxygen, and gravel particle size composition are substrate parameters affecting the survival of incubating salmonid embryos. Current methods of measuring these parameters cannot quantify all three without substantially disturbing the sample. To solve this problem, we developed a new technique to measure permeability and dissolved oxygen while extracting a freeze core from a single in-situ standpipe. The standpipe is similar to the Terhune Mark VI permeability standpipe, but it includes a plunger to seal the perforations and evacuate the water within the standpipe, allowing liquid nitrogen to fill the standpipe and freeze a

substrate sample. This gives biologists the opportunity to associate local gravel permeability and dissolved oxygen concentrations with physical substrate characteristics, including particle size distribution and vertical stratification. We developed a relationship between gravel permeability and steelhead (*Oncorhynchus mykiss*) embryo survival using Tappel and Bjornn's (1983) gravel quality index. This relationship shows that for permeabilities greater than 10,000 cm/hr, embryo survival was greater than 85 percent; however, considerable scatter exists for permeabilities lower than 10,000 cm/hr.



USDA  
Forest Service

## Forest Service Fish Habitat Relationships Program Leaders or Representatives

---

### **FHR Currents Purpose**

The USDA Forest Service Fish Habitat Relationships Program was established to further the development of fisheries technology and transfer this technology to field biologists. With ever increasing demands for natural resources, protection and management of aquatic communities requires biologists to be knowledgeable of current research findings and state-of-the-art techniques. The purpose of *FHR Currents* is to provide a vehicle to quickly disseminate information important to field-level biologists in the USDA Forest Service.

### **Submissions:**

If you wish to submit a paper for publication in *FHR Currents*, please contact the following people for information and guidelines:

**Jerry Boberg/Dave Fuller**  
Technical Editors  
(707) 441-3669  
**Stephanie Gomes**  
Editor/Designer  
(707) 441-3550

Six Rivers National Forest  
Fisheries Department  
1330 Bayshore Way  
Eureka, CA 95501



### **National FHR Program**

Jeffrey L. Kershner  
Washington Office  
Fish & Wildlife Department  
Utah State University  
Logan, UT 84322-5210

### **Region 1**

Kathy Moynan, Northern Region  
(Anadromous Fish Program)  
Nez Perce National Forest  
Route 2, Box 475  
Grangeville, ID 83530

Brian Sanborn, Northern Region  
(Resident Fish Program)  
Deerlodge National Forest  
Federal Building, Box 400  
Butte, MT 59703

### **Region 2**

R. Nick Schmal, Rocky Mountain Region  
Wildlife, Fish & Botany Staff  
Univ. of Wyoming, College of Agriculture  
P.O. Box 3354  
Laramie, WY 82071-3354

### **Region 3**

Bryce Rickel, Southwest Region  
Wildlife, Fish & Botany Staff  
Federal Building  
517 Gold Ave., S.W.  
Albuquerque, NM 87102

### **Region 4**

Seona L. Brown, Intermountain Region  
Wildlife, Fish & Botany Staff  
324 25th St.  
Ogden, UT 84401

### **Region 5**

Jerry Boberg, Pacific Southwest Region  
(Anadromous Fish Program)  
Six Rivers National Forest  
1330 Bayshore Way  
Eureka, CA 95501

Jeffery Reiner, Pacific Southwest Region  
(Resident Fish Program)  
Lake Tahoe Basin Management Unit  
870 Emerald Bay Rd., Suite 1  
South Lake Tahoe, CA 96150

### **Region 6**

Deborah Konhoff, Pacific Northwest Region  
Wildlife, Fish & Botany Staff  
333 S.W. 1st Ave., PO. Box 3623  
Portland, OR 97208

### **Region 8**

Cindy A. Williams, Southern Region  
Wildlife, Fish & Botany Staff  
1720 Peachtree Rd.  
N.W. Atlanta, GA 30367

### **Region 9**

Don Hair, Northeast Region  
Nicolet National Forest  
Federal Building, 68 South Stevens  
Rhineland, WI 54501

### **Region 10**

Ron Dunlap, Alaska Region  
Wildlife, Fish & Botany Staff  
Federal Office Building, Box 21628  
Juneau, AK 99802-1628

### **Intermountain/Northern Region**

Kerry Overton, Fish Research Work Unit  
Intermountain Research Station  
316 E. Myrtle St.  
Boise, ID 83702

### **Associates**

---

Glenn Chen  
Fisheries Biologist/Monitoring Specialist,  
USDA Forest Service  
Fish & Wildlife Department  
Utah State University  
Logan, UT 84322-5210

David Fuller  
Fisheries Biologist, USDA Forest Service  
Six Rivers National Forest  
1330 Bayshore Way  
Eureka, CA 95501

Ken Roby  
Hydrologist, USDA Forest Service  
Pacific Southwest Experiment Station  
PO. Box 245  
Berkeley, CA 94701-0245

Larry Schmidt  
Stream Systems Technology Center  
USDA Forest Service  
Rocky Mountain Experiment Station  
240 W. Prospect  
Fort Collins, CO 80526-2098

Mark Vinson  
Hydrologist/Monitoring Specialist,  
USDI Bureau of Land Management  
Fish & Wildlife Department  
Utah State University,  
Logan, UT 84322-5210

## Introduction

All watersheds contribute a portion of their total sediment load to the stream as fine sediment. Fine sediments infiltrate the gravel column and can be detrimental to salmonid spawning habitat. The amount of fine sediment delivered to streams depends on several factors, including watershed geology, climate, vegetation, and land use. The latter is a critical issue for fishery biologists because it is the only factor that can be modified by alternative watershed management techniques. Salmonid eggs, buried under as much as a foot of gravel, depend on sufficient intragravel water flow for their survival and development. Platts, et. al., (1983) found that a large percentage (>20 percent) of fine sediment within spawning gravel impedes flow and the survival of eggs is jeopardized. To date, the principal parameter for assessing gravel quality has been the percentage of fine sediment within the entire gravel column (Chapman, 1988). Platts, et. al., (1983) and others have observed a direct relationship between percent fines and egg to emergence success for salmonids. Tappel and Bjornn (1983) performed a similar analysis, using a gravel quality index dependent on the particle size distribution less than 26.4 mm instead of percent fines. However, the interrelationships between percentage of fines, permeability, and dissolved oxygen (DO) have seen little attention. In his review of salmonid spawning gravel literature, Chapman (1988) concludes that further research of the physical and biological dynamics of redds is needed, including the effects of intragravel permeability, DO, and particle size distribution on egg survival.

These interrelationships have been neglected because measuring each parameter in-situ using a single sampling device has proved difficult. Gravel core samplers developed by McNiel and Ahnell (1960) and Walkotten (1976) do not permit measures of permeability or DO. In contrast, Terhune (1958) developed a standpipe that measured permeability and DO but could not

extract a gravel core for particle size analysis. Because gravel permeability and particle size distribution can be spatially highly variable, a desirable sampling technique would be precise enough to adequately characterize localized gravel quality parameters. Currently, the only method of measuring in-situ permeability, DO, and particle size distribution is to:

1. drive a perforated standpipe into the gravel;
2. measure permeability and DO in place;
3. extract the pipe;
4. insert a non-perforated standpipe back into the gravel; and
5. apply a cryogenic medium into the standpipe to extract a gravel core.

This method is unacceptable because re-inserting the standpipe disturbs the integrity of the sample.

Instream bulk samples are typically obtained using a McNiel sampler (McNiel and Ahnell, 1960). For certain applications, this sampling technique can provide rapid and economical bed particle size information; however, it is limited by the difficulty in inserting the sampler to depths greater than 30 cm, and direct observation of vertical bed stratification is impossible. Conversely, standpipe freeze core samples can be as deep as 60 cm, and can also retain the natural bed stratification. This provides the opportunity to observe biological organisms (salmonid embryos and alevins, aquatic invertebrates, etc.) in a natural setting. The standpipe is particularly suited to sampling in salmonid spawning areas where water depths are less than a meter and velocities are less than one meter per second. The standpipe is limited because highly permeable gravel reduces the freezing effect of the cryogenic liquid, such that gravel samples are sometimes too small to be acceptable. In addition, the apparatus required is less portable than that for bulk sampling.

We have modified Terhune's permeability standpipe so that permeability, DO, and a freeze core can be taken without removing the standpipe, allowing us to compare these parameters with minimal gravel disturbance. The standpipe is driven into the gravel sample, and intragravel permeability and DO are measured. The standpipe is driven slightly deeper and a synthetic rubber plunger is placed into the pipe to evacuate water from the standpipe. Liquid nitrogen can now be poured into the standpipe, freezing the surrounding gravel to the outside of the standpipe. The pipe with the frozen core is

extracted from the substrate, thawed to remove the gravel, either as an entire sample or separated into vertical strata which are then sieved into particle sizes and weighed.

## Methods

### Field Equipment

A stainless steel freeze core standpipe allows liquid nitrogen to serve as the cryogenic medium. The 3.8 cm (inner) diameter standpipe measuring

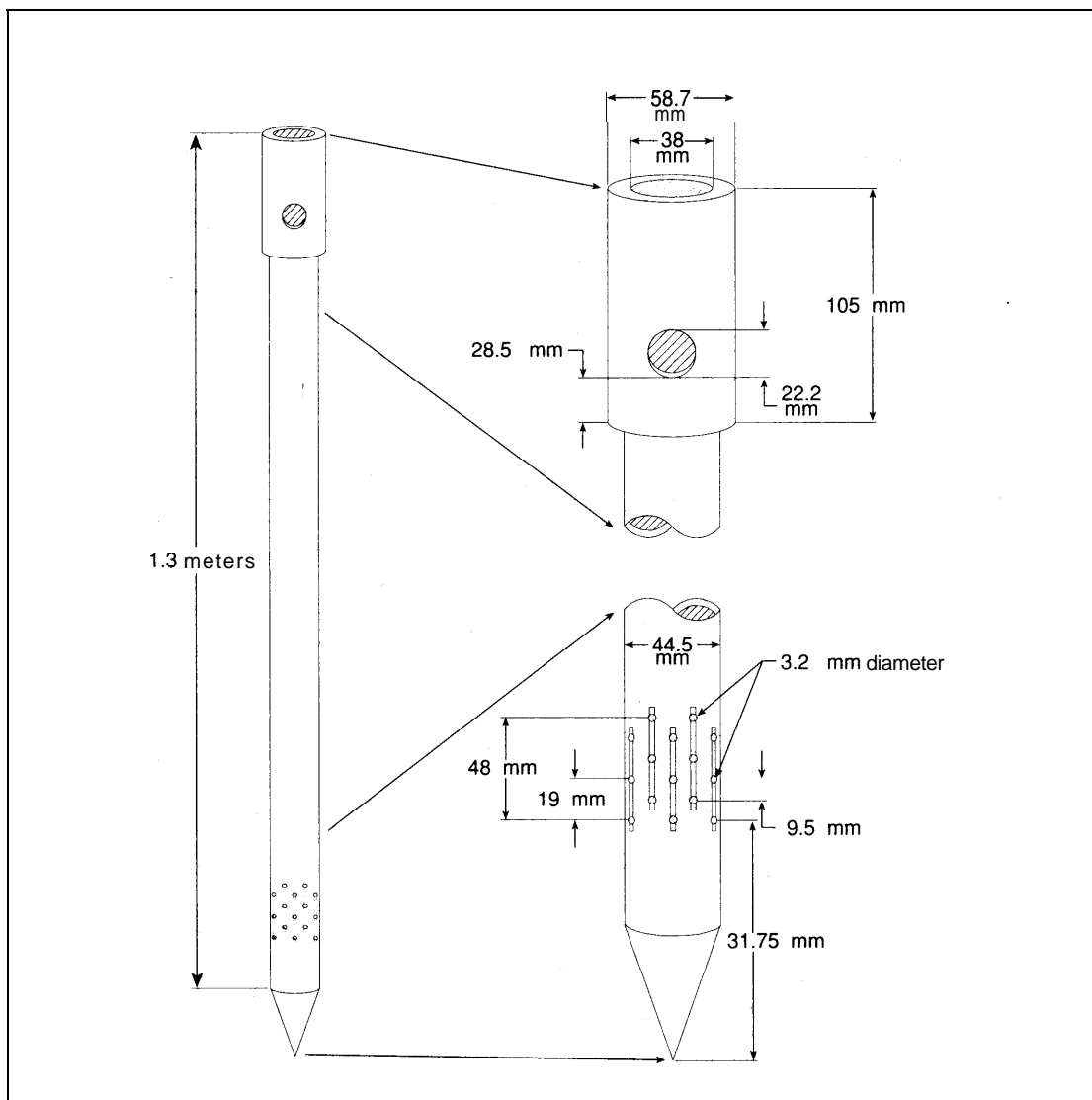

Figure 1. Modified Terhune Mark VI standpipe

1.3 meters long is closed at one end by a stainless steel driving point (Figure 1). It is identical to Terhune's (1958) standpipe except that a 3.8 cm diameter stainless steel pipe replaces Terhune's less durable 3.2 cm aluminum standpipe.

The lower end immediately above the driving point is perforated with forty-eight 3.2 mm diameter holes in 16 evenly spaced rows of three (Figure 1). The large number of holes is necessary to imitate a spherical sink, allowing the water to freely flow into the standpipe from anywhere in

the adjacent gravel column (Terhune 1958). Each vertical row of holes is connected by grooves 1.6 mm wide and 1 mm deep to minimize blockage of the holes by small particles.

When the modified standpipe is driven into the gravel, intragravel water enters the pipe through the holes and rises to the level equal to the outside water surface. A graduated suction apparatus maintains a 2.5 cm pressure head (Figure 2), causing water to flow through the gravel and into the standpipe. In maintaining this pressure head,

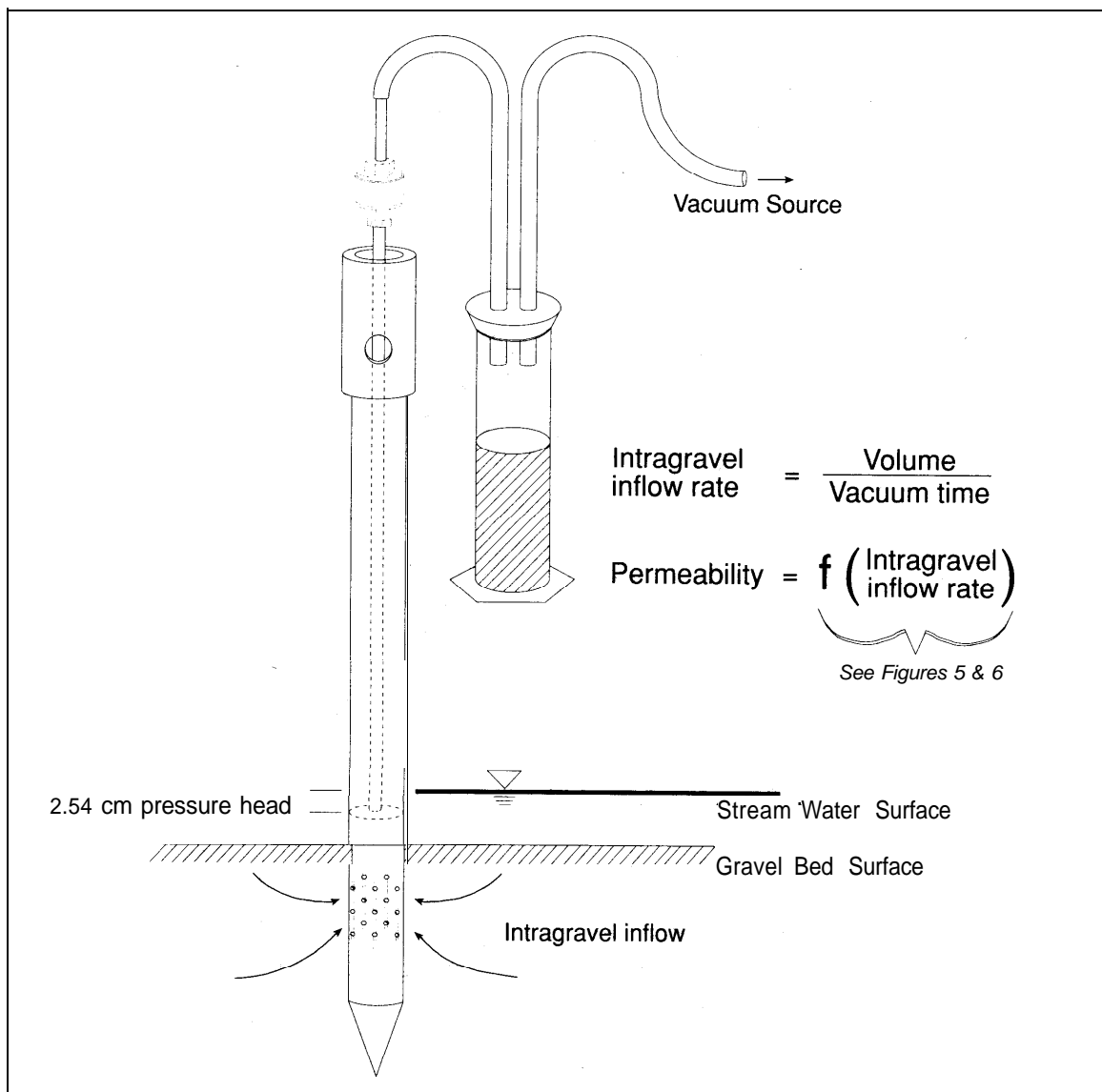

Figure 2. Permeability measurements using the modified standpipe

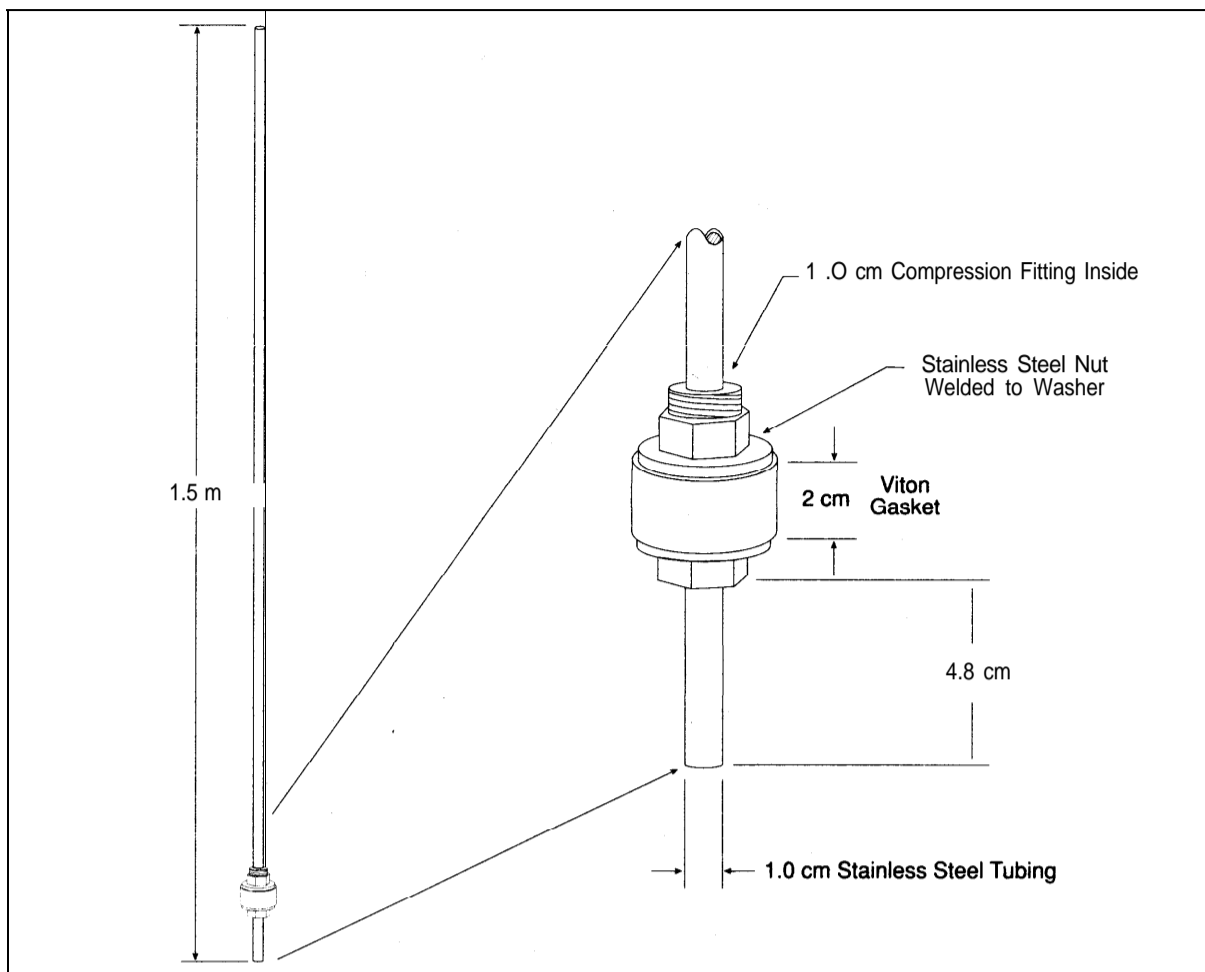

Figure 3. Freeze core plunger for the modified standpipe

the suction apparatus evacuates water from the standpipe at a rate equal to inflow. This water is stored in a 1,000 ml graduated cylinder so that the volume per unit time (i.e., inflow rate) can be measured.

Gravel permeability measurements require unimpeded intragravel water flow into the standpipe. However, a successful freeze core demands that water be excluded from the standpipe so that the maximum freezing effect of the liquid nitrogen is directed to the gravel/standpipe interface. To make the permeability standpipe also function as a freeze core standpipe, a plunger prevents water from filling higher than the top of the perforations. The plunger is a 1.5 m

long, 1 cm diameter stainless steel tube that has a synthetic gasket at one end (Figure 3). The gasket is made of "Viton," a synthetic rubber that resists cracking and splitting at extremely low temperatures. The outer diameter of the disk is cut to fit tightly into the standpipe.

When the plunger is fully inserted into the standpipe, the disk is located above the topmost perforation to prevent inflow above the perforations (Figure 4). To assure a satisfactory seal and allow removal of the plunger, a "socket" made of a 1.2 m long by 2.5 cm diameter iron pipe allows the operator to tighten or loosen the disk fitting while it is inside the standpipe. The disk is initially tightened to expand the flexible disk,

assuring a waterproof seal. Loosening the disk fitting after taking the core releases the seal and eases removal from the standpipe.

**Field Methods**

*Dissolved Oxygen Measurements*

Once a sample site is selected, the standpipe is driven into the gravel column until the perforations reach the desired sampling depth. To measure intragravel DO (or any other water quality parameter), water in the standpipe must be removed because it includes surface water. When water is pumped out of the standpipe, intragravel water refills the standpipe from the desired sample depth. An electronic probe can then be lowered into the standpipe to measure dissolved oxygen.

*Permeability Measurements*

Two people are required to measure permeability. One person (pumper) holds the graduated cylinder and operates the pump while a second person (timer) lowers the inverted steel plunger into the standpipe and listens for a characteristic “slurp,” indicating that the end of the plunger tubing has just made contact with the water surface inside the standpipe. A 2.54 cm wooden spacer is placed on top of the standpipe and a “visegrip” is attached to the plunger at the top of the spacer. When the spacer is removed, the plunger is lowered until the visegrip rests on top of the standpipe, thereby holding the end of the plunger tubing exactly 2.54 cm below the water surface within the standpipe (Figure 2).

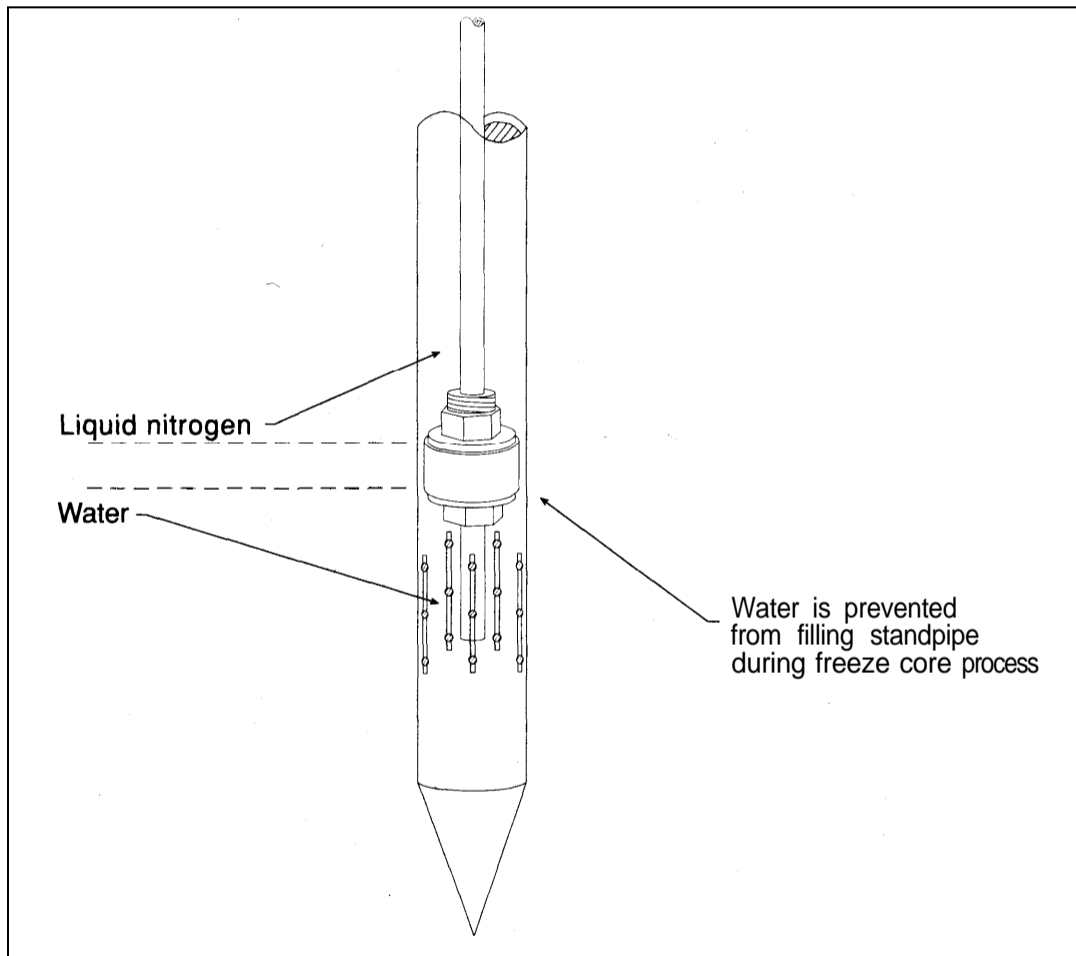

Figure 4. Schematic of freeze core plunger inserted in to the modified standpipe



*A bilge pump is used to extract wafer in measuring permeability.*

The timer then pinches the flexible tubing connected to the plunger and operates the stopwatch. The pumper operates the bilge pump (or other vacuum source), creating a vacuum throughout the graduated cylinder. Once a sufficient vacuum is generated (2-5 seconds), the timer simultaneously releases the pinched tubing and starts the stopwatch while the pumper continues. The vacuum immediately removes the top 2.5 cm of water, creating a pressure gradient that drives intragravel water into the standpipe. Water from inside the standpipe is continuously drawn into the graduated cylinder until the cylinder is almost full or an appropriate amount of time has elapsed (30-60 seconds). The timer simultaneously raises the plunger from the water surface and stops the stopwatch.

Inflow rate, the ratio of measured water volume per unit time, must be corrected to account for the initial 2.5 cm water column and the time required to remove it. The volume of the 2.5 cm of water (29.0 ml for the 3.8 cm pipe) is subtracted from the measured volume, and the time taken to

remove it from the standpipe (estimated at 0.25 seconds) is subtracted from the measured time (Terhune 1958). The sample permeability is interpolated from an empirical permeability versus corrected inflow rate calibration curve (discussed below, Figure 5). This permeability value "KT" should be standardized to a temperature of 10 degrees Celsius by a viscosity correction factor "X" (Figure 6; Terhune, 1958) as:

Equation #1

$$K_{10} = XK_T$$



*Liquid nitrogen is poured into the standpipe to freeze a substrate sample after the permeability has been measured.*



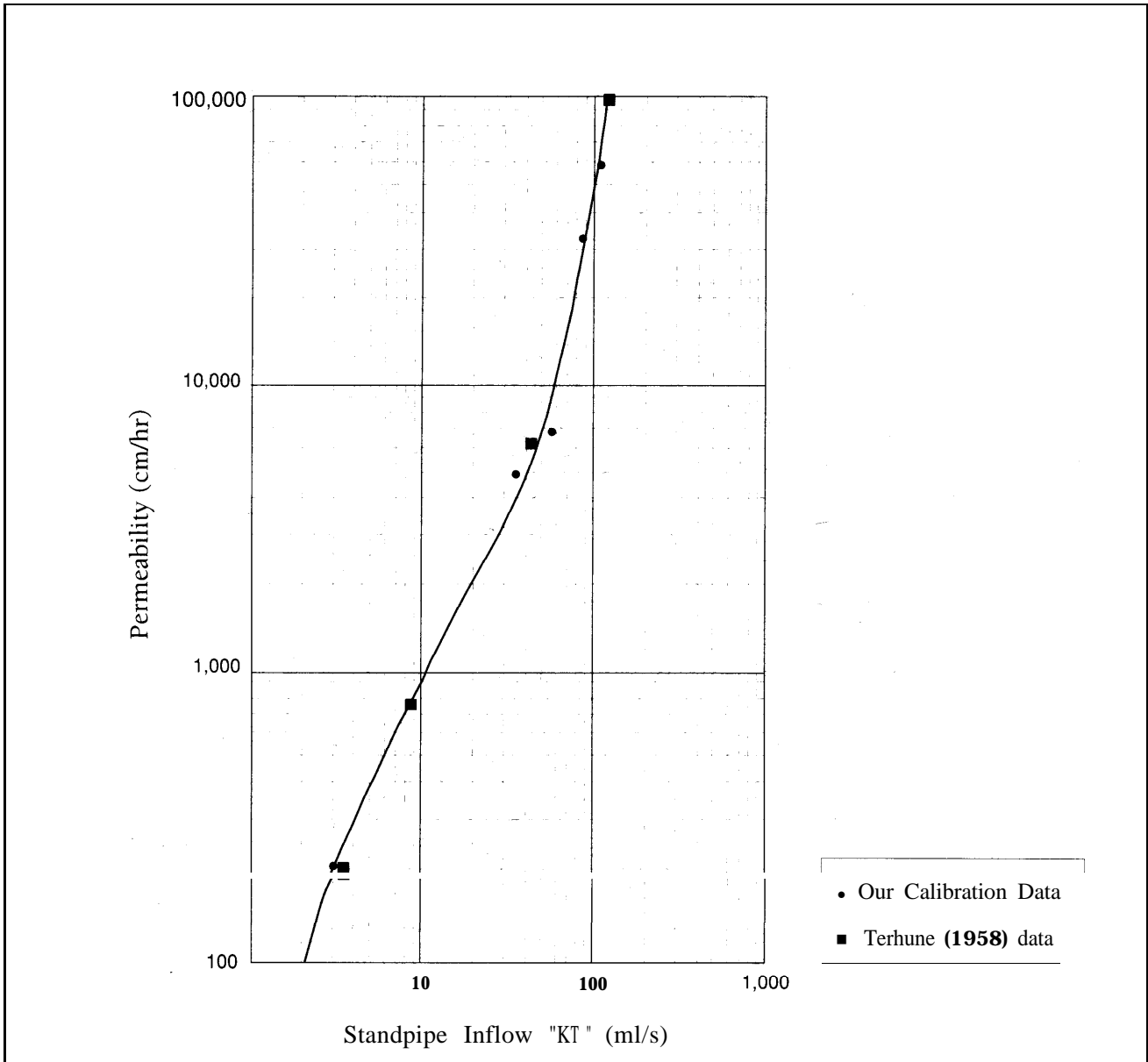

Figure 5. Permeability vs. standpipe inflow rate calibration curve

*Freeze Core Sampling*

Because the gravel core freezes to the standpipe above the perforations, the standpipe is driven an additional 5 cm so the permeability measurements will be represented in the gravel core. Next, the plunger is inserted into the standpipe; the vacuum apparatus is attached to the top end of the plunger. One person pumps water from the standpipe as the other slowly pushes the plunger

into the standpipe until the disk is located just above the top perforations. By pumping water while inserting the plunger, water is not forced back through the perforations, which avoids flushing fines from the gravel sample. At the same time, the pumping removes most water from the plunger tubing, reducing metal fatigue to the tubing caused by ice expansion. Once the plunger reaches the top of the perforations, liquid nitrogen is poured from a Dewar flask into the standpipe,

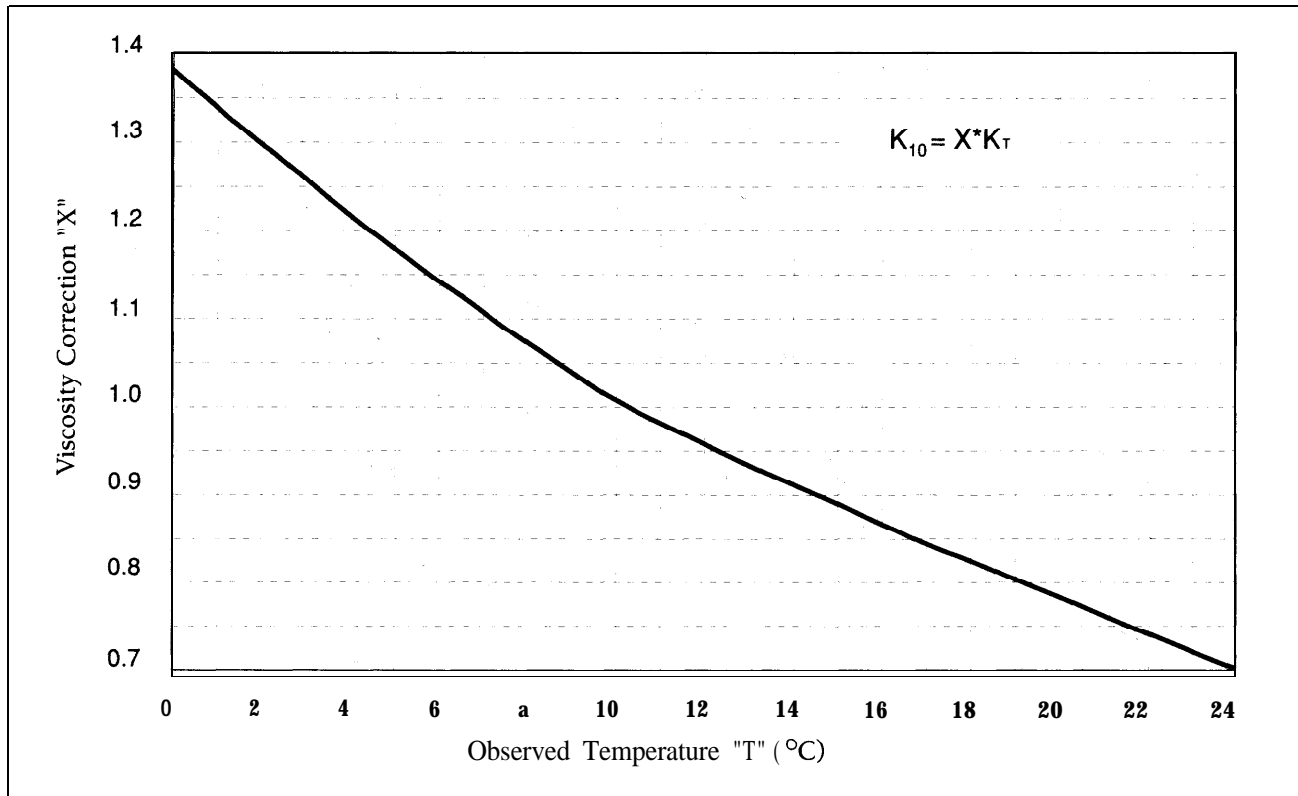

Figure 6. Permeability correction curve to account for viscosity changes with temperature

and the vacuum apparatus is removed from the plunger. As the liquid nitrogen boils and vaporizes in the standpipe, the gravel column begins to freeze to the sides of the standpipe.

In gravel sites exhibiting high permeability (>70,000 cm/hr), a successful freeze core often depends on deflecting the surface and intragravel water flow around the standpipe. This is accomplished by pushing a large sheet metal collar into the gravel surrounding the standpipe and placing a sandbag against the upstream side of the collar. The collar and sandbag must be used after the permeability measurements have been taken because they will reduce intragravel flow.

Best results are obtained when the liquid nitrogen level in the standpipe is maintained above the gravel surface. Eight to 10 liters of liquid nitrogen are usually sufficient to produce a 25-40 cm

diameter core unless gravel permeability is high, in which case more nitrogen may be necessary. For samples with permeability more than 70,000 cm/hr, up to 15 liters of nitrogen may be required.

When the last of the liquid nitrogen in the standpipe is allowed to vaporize, a steel rod is inserted through the holes near the top of the standpipe. Two people then pull the standpipe (with the attached frozen gravel sample) from the streambed. The gravel sample is thawed, separated into vertical strata (Platts, et. al. 1983), and sieved to separate particle size classes.

*Permeability Calibration*

The Terhune method of determining permeability requires that permeability be interpolated from the measured sample inflow rate using a “Permeability vs. Standpipe Inflow” calibration curve (Figure 5).

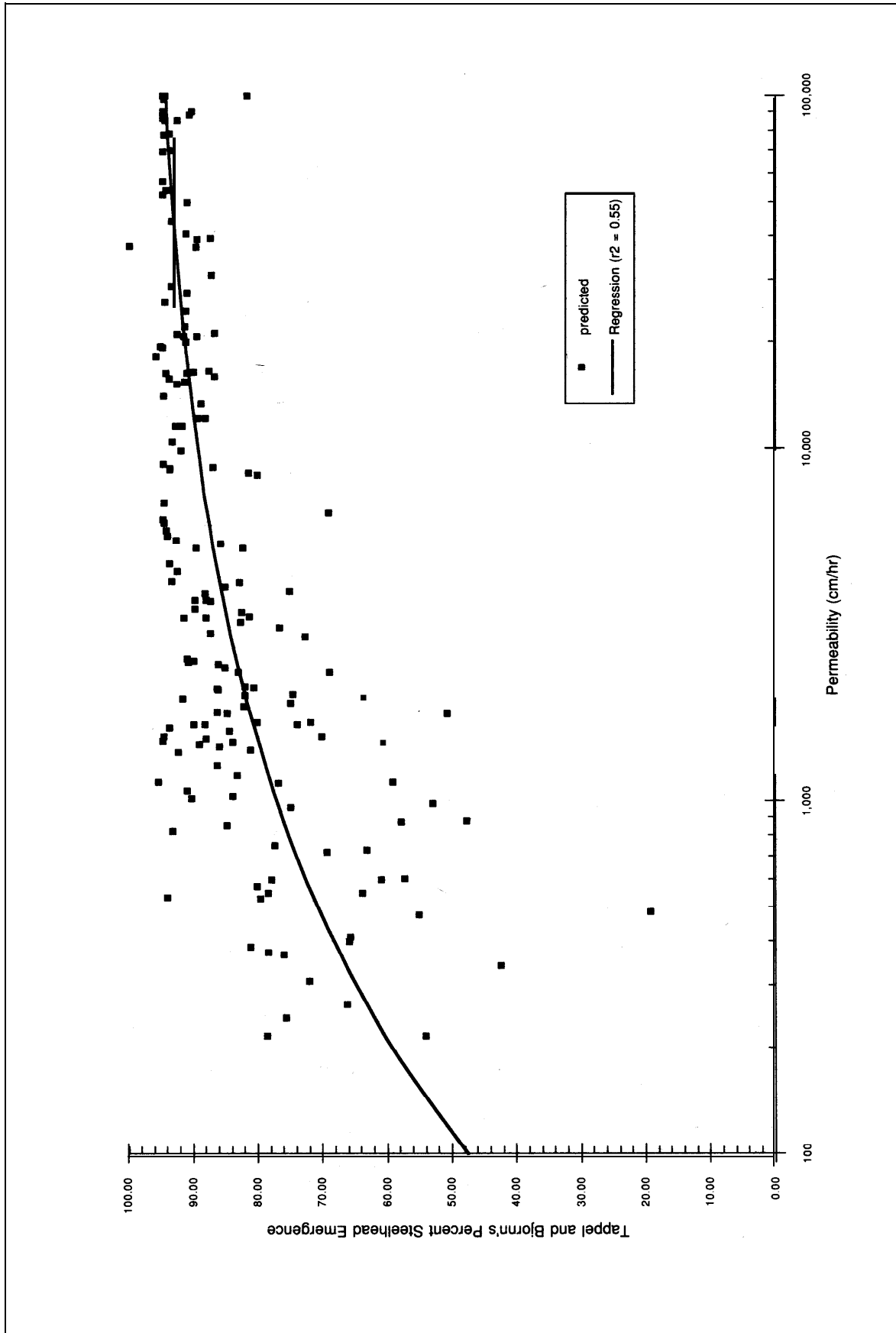
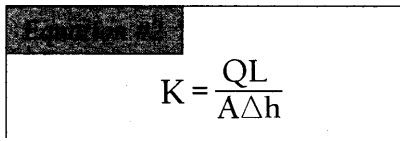

Figure 7. Permeability vs. Tappel and Bjorn (1983) Steelhead Emergence Survival

The calibration curve that Terhune (1958) developed was appropriate for his 3.2 cm aluminum standpipe. Because our modified standpipe design uses a larger diameter stainless steel pipe, we redeveloped a calibration curve for the new standpipe.

We constructed a hydraulic flume permeameter to measure the permeability of a homogeneous but non-uniform gravel mixture. As water flowed through the gravel-filled permeameter, we measured the following four properties: 1) the flow rate through the gravel mixture ( $Q$ , cm<sup>3</sup>/hr); 2) the length of the gravel mixture ( $L$ , cm); 3) the average cross-sectional area of the wetted gravel mixture ( $A$ , cm<sup>2</sup>); and 4) the change in height of the water level over the distance  $L$  ( $h$ , cm) using simple piezometers. Permeability ( $K$ , cm/hr) of the gravel was then calculated according to the following equation developed by Darcy (1856) and adapted by Terhune (1958):



$$K = \frac{QL}{A\Delta h}$$

Once the permeability of the gravel mixture was determined, five modified standpipes were placed in the gravel mixture and the inflow rate for each was measured (as described in the previous section). Inflow rates for each gravel mixture were averaged. Five homogeneous gravel mixtures were used for the calibration curve (Figure 5).

Permeability ( $K$ ) and average inflow rates ( $Q$ ) were plotted on log-log paper to estimate the appropriate calibration curve (Figure 5). A curve was fitted by eye through the remaining five data points, and the curve for the modified standpipe was nearly identical to the Mark VI standpipe (Terhune 1958). The calibration results suggest that the calibration curve is applicable for Terhune's and our new standpipe, so future calibration is unnecessary if the perforations are prepared according to this paper or the Terhune (1958) design.

## Application

Gravel quality is a critical component of a healthy stream and the reproductive success of salmonids. The survival rate of eggs to emergence determines the initial population size of a cohort, and is, in part, dependent on permeability, DO, and particle size distribution. For the first time, measuring these gravel quality parameters with a single device at a single location is possible, providing an accurate and cost effective way of collecting these data.

One byproduct of the particle size distribution is that we are able to relate percent fines (Platts, et al. 1983) or other gravel quality indices (Tappel and Bjornn 1983) to the survival rate of eggs to emergence. Additionally, this technique is a quick and cost effective way for fisheries managers to monitor temporal and spatial variability of gravel quality parameters in streams. This technique has several potential management applications, including:

- (1) Substrate sampling within selective redds would provide data relating egg to emergence survival rate, producing better estimates for yearly cohort production for a given stream;
- (2) Localized spawning habitat quality-could be assessed by measuring particle size distributions, permeability and DO; and
- (3) Long term monitoring of particle size distributions, permeability, and DO could document impacts of land use practices on gravel quality within an entire watershed or the contribution from a single tributary.

## Permeability vs. Salmonid Survival

Gravel particle size distribution and permeability are inter-dependent. For example, we collected 185 in-situ permeability/particle size distribution measurements on Freshwater Creek, McCloud River, Trinity River, and Tuolumne River, and found a positive correlation between permeability

and several gravel quality indices. Two gravel quality indices, the fredle index and the Tappel and Bjornn index, have been related to salmonid emergence survival (Platts, et. al., 1983; Tappel and Bjornn, 1983). We then:

- (1) computed the respective index from our particle size data;
- (2) predicted survival for steelhead using the above survival relationships; and
- (3) compared log (permeability) the survival estimates.

Of these, the Tappel and Bjornn survival index provided the best results (Figure 7). The Tappel and Bjornn index is:

$$\text{Steelhead Survival \%} = 94.7 - 0.116S_{9.5}S_{0.85} + 0.007(S_{9.5})^2$$

where  $S_{9.5}$  and  $S_{0.85}$  is the percent (by weight) of the sample that is smaller than 9.5 mm and 0.85 mm, respectively. The best fit regression equation for steelhead ( $r^2 = 0.55$ ) is:

$$\text{Steelhead Survival \%} = 97.95 - e^{-0.88(\log \text{permeability})}$$

Our data suggest that for permeabilities above 10,000 cm/hr, steelhead emergence survival is greater than 85 percent. However, considerable scatter is evident at lower permeabilities. This inhibits the usefulness of this technique as a management tool because low gravel permeabilities are commonly observed on impacted watersheds; therefore, the ability to assess the impact of watershed disturbance to salmonid survival is problematic. Therefore, confidence in Equation (3) is low for permeabilities lower than 10,000 cm/hr.

A considerable portion of the scatter in Figure 7 is a result of estimating the value of both the dependent (salmonid emergence survival) and independent (permeability) variables. The dependent variable (permeability) is estimated by measuring inflow and interpolating from Figure 5, and the independent variable is estimated by measuring the particle size distribution and then calculating survival from Tappel and Bjornn's model. Each of these steps adds to the uncertainty in the permeability vs. salmonid emergence survival relationship. Therefore, a desirable alternative would be to derive a direct relationship between standpipe inflow and salmonid emergence survival. We are currently seeking funding to fulfill this research need.

## Acknowledgments

This study was funded in part by Humboldt State University, Humboldt State University Foundation, and the USDA Cooperative State Research Program (M&tire-Stennis). The authors gratefully acknowledge Dr. Terry Roelofs, Dr. William Trush, and the Humboldt State University Fisheries Department for their support and patience. Additional thanks go to Don Allan and others who helped develop the methodology and conduct the field testing of the modified standpipe.

Photographs by Michael G. Harmon.

- Keith Barnard is currently at Trinity Associates, PO. Box 820, Arcata, CA 95521.
- \*Scott McBain is currently at 238 Karen St., Quincy, CA 9.5971.

## References

Chapman, Don W. 1988. Critical Review of Variables Used to Define Effects of Fines in Redds of Large Salmonids. American Fisheries Society Transactions. **117: 1-21.**

Darcy, H. **1856.** Les fontaines publiques de la Villa de Dijon, Dalmont, Paris

McNiel, W.J., and W.H. Ahnell, 1960. Measurement of Gravel Composition of Salmon Stream Beds, University of Washington Fisheries Research Institute, Circular No. 120,3 p.

Platts, W.S., W.F. Megahan, and G.W. Minshall, 1983. Methods for Evaluating Stream, Riparian, and Biotic Conditions, U.S.D.A. Forest Service General Technical Report INT-138, 70 p.

Tappel, P.D., and Bjorn, T.C.. 1983. A New Method of Relating Size of Spawning Gravel to Salmonid Embryo Survival, North American Journal of Fisheries Management, 3: 123-135.

Terhune, L.D.B. 1958. The Mark VI Groundwater Standpipe for Measuring Seepage Through Salmon Spawning Gravel. Canada Fisheries Research Board Journal, 15: 1027-1063.

Walkotten, W.J., 1976. An Improved Technique for Freeze Sampling Streambed Sediment, U.S.D.A. Forest Service General Technical Report, PSW-281, 11 p.

